



University of Bologna  
 Dipartimento di Informatica –  
 Scienza e Ingegneria (DISI)  
 Engineering Bologna Campus

Class of **Infrastructures for Cloud  
 Computing and Big Data M**

**CORBA, C/S and Events, Multicast, MOM**

**Antonio Corradi**

Academic year 2018/2019

C/S MW and more 1

**REMOTE REFERENCES**

In **many local environments** (in **object-oriented** system), we need the capacity of **referring to some external resources**, in order to coordinate different machines (virtual or physical)

A **C1 on one node** must refer to a **remote instance**, the same as if they were local instances on the same node

To refer to a remote instance we need some **intermediary support that extends the visibility to remote nodes**

In some cases,  
**local and remote references are uniformed** via **local intermediaries (proxies)** that play the enabling role and typically mask support transparently

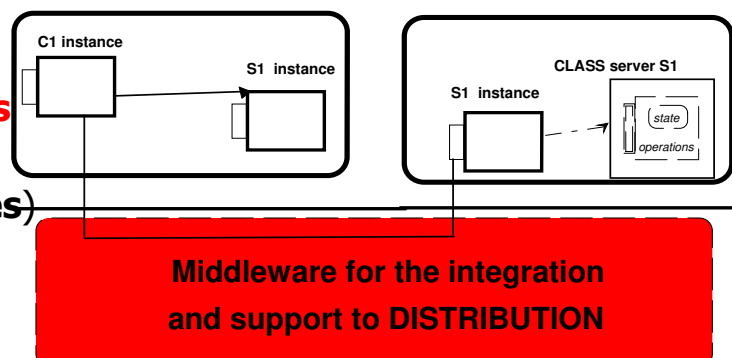

# RMI REMOTE REFERENCES

Between two JAVA JVM systems, we can use Java Remote Method Invocation (RMI) that build two proxies

- one from the customer (stub)
- one on the side of the servant (skeleton)

Such proxies are often **generated automatically** and make the user part reasoning regardless of the specific deployments

Similarly other environments (**CORBA, DCOM**, etc.) define their specific support for OO cases

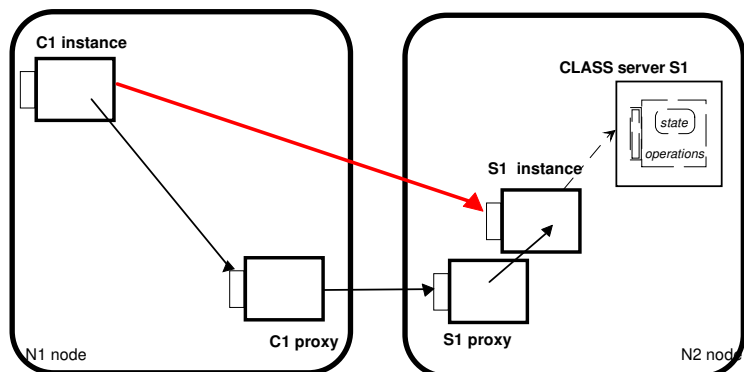

**Middleware for the integration and support to DISTRIBUTION**

Models 3

## REMOTE REFERENCES via PROXY

Two Java virtual machines can use **PROXIES to get remote visibility of object references**

RMI support many solutions but proposes problems:

- How do you get the reference to the server? (name system)
- Where are the ancillary classes?
- How to obtain them (while running)?
- And if there are any inconsistencies?
- And if the server is not active?
- And if you don't keep the status?

About **remote references**:

- two references to the same object?
- two references for the same service?

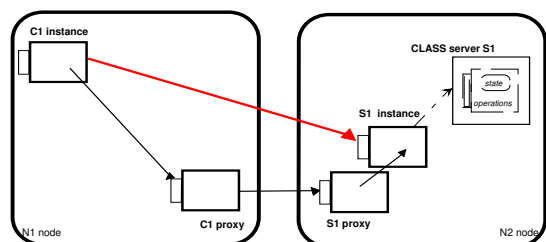

**Middleware for the integration and support to DISTRIBUTION**

Models 4

# REMOTE REFERENCES & MIDDLEWARE

A central point in all middlewares that **abstract away and hide details from users for remote access** is how to enable and manage a **remote reference** in all its aspects

A remote reference allows access to non-local entity must surely be transparently

But costs must be considered and evaluated for each aspects of the support mechanism

- How does the remote reference cost?
- How is the cost of middleware to support organization?
- How to obtain remote references?
- Are inconsistencies possible?
- What are the responsibilities of the middleware? ...
- ...

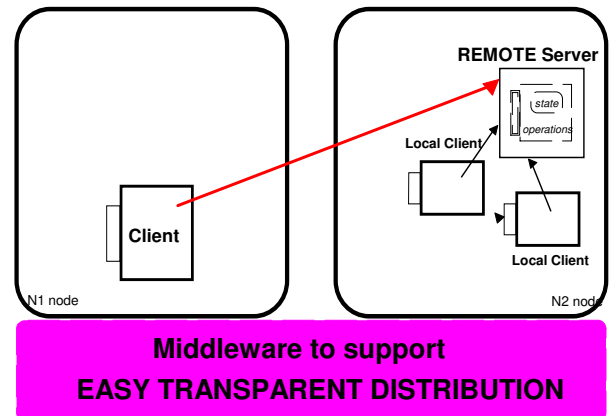

# INTERMEDIARIES & PROXIES

## PROXY

In a communication we may have intermediaries placed and deployed either side, the client and the service provider

### Requests

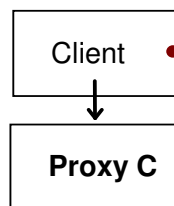

### Operations

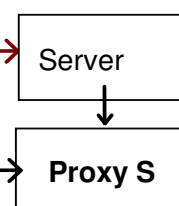

## PROXY

from client or from server

### Requests

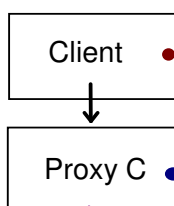

### Operations

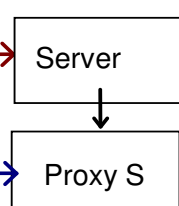

## proxy

C/S stub & skeleton

## interceptor

to add functions

## broker

something similar to a container

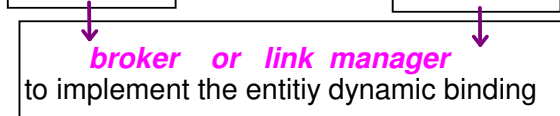

# MIDDLEWARE: CORBA as a C/S MW

## OMG- Object Management Group

**CORBA** started in 1989 with **440 company** Microsoft, Digital, HP, NCR, SUN, OSF, *etc.* with main objective to create a **use and management system** of a **distributed architecture**

**Common Object Request Broker Architecture**

**CORBA standard** v1 ⇨ 1991, v1.2 ⇨ 1992

v2 ⇨ 1996, v3 ⇨ 2000

**Orbix** SunOS Solaris, Iris, Windows NT, HP/UX, AIX, OSF/1, UnixWare

**DSOM** IBM

**General specification of an Object (component) Middleware to use in heterogeneous distribute systems not tied to a specific language**

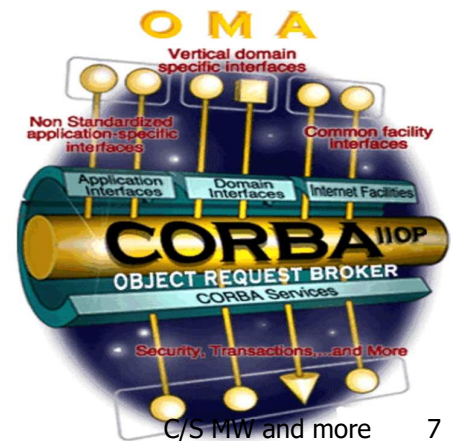

7

## MIDDLEWARE: CORBA

**STANDARD OPEN SYSTEM based on OBJECT models with heterogeneous components to implement mutual and complete interaction and integration between such components, inside distributed environments also objects oriented (C/S model)**

**CORBA requires:**

- definition of a **language as service interface**
- definition and support to **objects interaction**
- **integration bus** for **different environments** objects (**ORB**)
- **interaction** between systems with different managers
- **different deployment languages** (**language mapping**)

The objective is to allow **services support** without posing **limits** on user application **lifecycle**

# CORBA ARCHITECTURE

Common **Object Request Broker Architecture CORBA**, as a **common environment**, **Object Management Architecture**, for **multi-architecture and multi-language scenarios**, with an optimal integration with legacy systems and best support for differentiated projects for server and clients

**Object Request Broker (ORB)** is the **heart** of the **architecture** and acts as a **broker of communication**, to allow both **static and dynamic** links (!?) between entities

**ORB** behave as an always available enabler and allows:

- control of **allocation** and **visibility** of objects
- control of **methods** and of **communication**
- control of **accessory services** always available inside OMA for every language mapping
- **simplified management** of every possible services

**CORBA is middleware to support an infinite lifetime for applications**

C/S MW and more 9

## CORBA as a BUS

**ORB** is the **center** of **Object Management Architecture**  
**ORB** as a **bus center of an architecture** that aims at the integration among **every resources of an organization**

Every managed application objects can belong to **different environments** and must be able to **mutually communicate** without any need of **redesign**

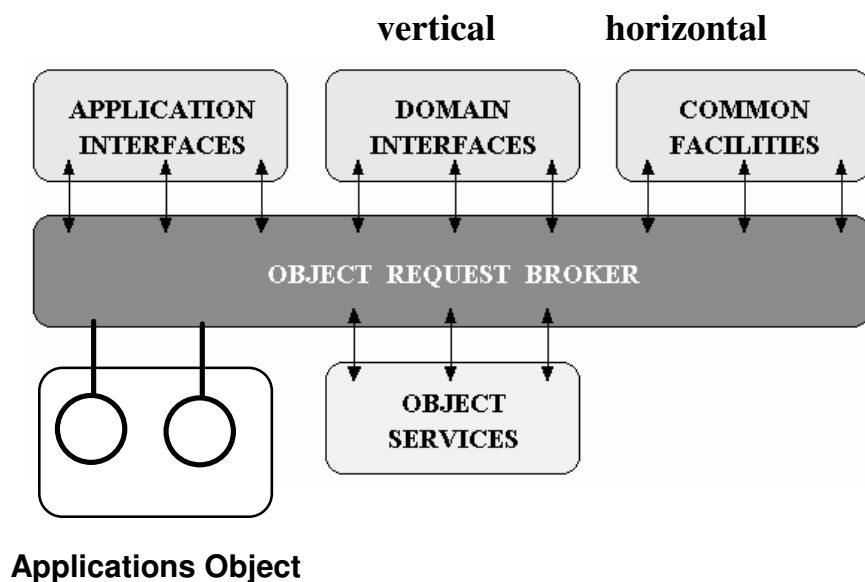

C/S MW and more 10

# Object Management Architecture

Other additional environment components

## Common Facilities CF (horizontal)

Set of specific features

User Interface (client-site),

System Management, Information, Task (server-site)

## Domain Interfaces DI (vertical)

Features dedicated to application areas, for ex. manufacturing, telecommunications, electronic commerce, transportation, business objects, healthcare, finance, life science, ...

## Application Interfaces

Non standard in any way and application-dependent

C/S MW and more

11

# Object Management Architecture - OMA

## Ambiente Object Framework

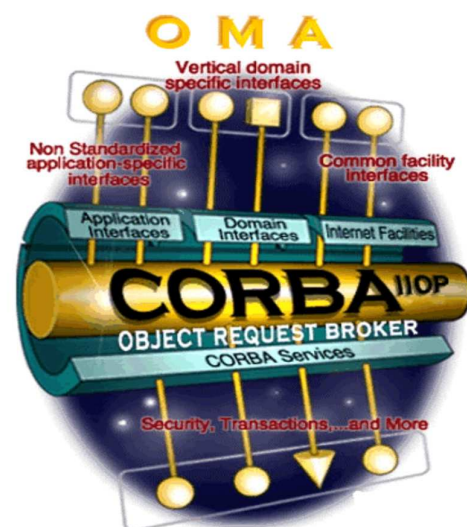
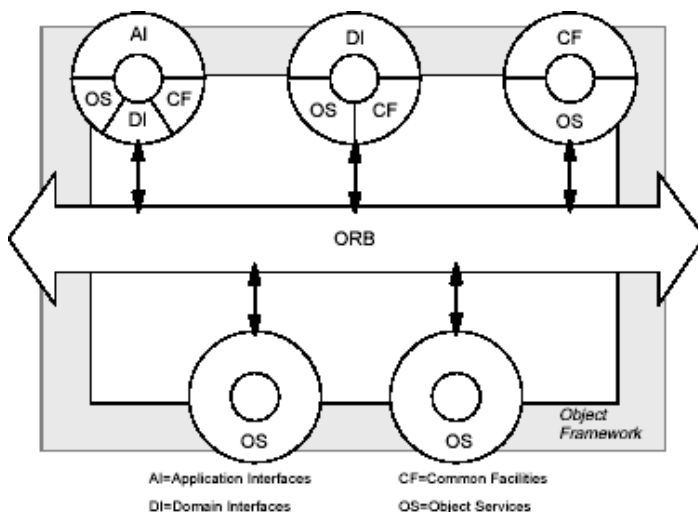

C/S MW and more

12

# Object Management Architecture

---

**Every component can connect to every other one, preparing link either before or during execution (if unknown before), using the service of one or more ORB (known dynamically)**

Set of **additional environment components**

**Object Services or CORBA Services** (*Common Mw Services*)

Some operations are basic for object

- **naming** and **trading** service (compatible with OO)
- **event** and **notification** service (less Object-Oriented)

In addition to further operations (or services)

For lifecycle management, relational, transactional, concurrency control, security, ...

## CORBA COMPONENTS

---

The essential components of OMA architecture, i.e., CORBA, associated to an ORB:

- **Object Request Broker** (ORB)
- **Interface Definition Language** (IDL)
- **Basic Object Adapter (e POA ...)** (BOA e POA)
- **Static Invocation Interface** (SII)
- **Dynamic Invocation Interface** (DII)
- **Interface e Impl. Repository** (IR e IMR)
- **Integration Protocols** (GIOP)

Those components are at very different level

# ORB CONTINUOUS SUPPORT

**Object Request Broker (ORB) must coordinate invocation of local and remote services (dynamically)**

- Identify **implementation of an object** as a servant to requests (object location)
- prepare the **servant** to receive the request - via *adapter* (object creation, activation & management)
- transfer **the request** from the client to the servant
- return **reply** to client

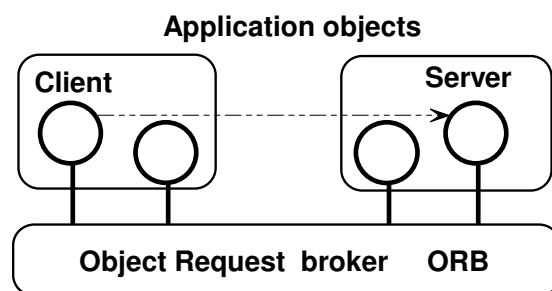

C/S MW and more 15

# CORBA: DYNAMIC VISION

## Elements in action: overall user view

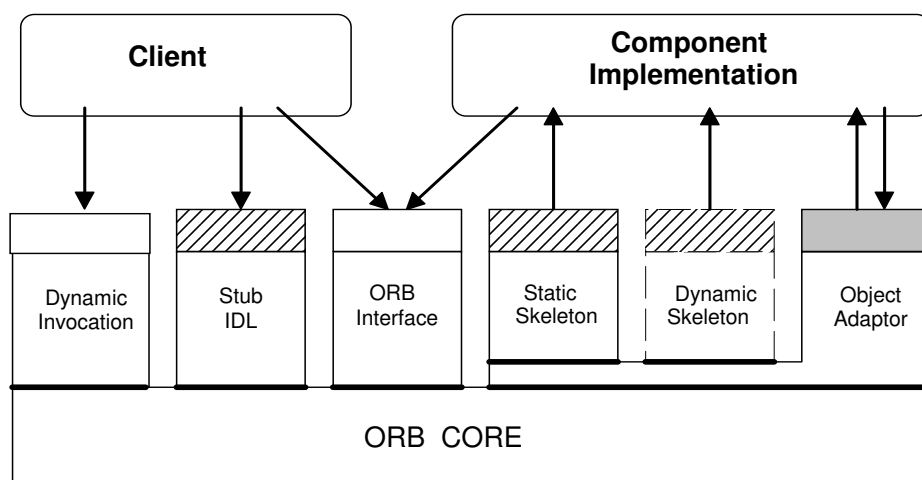

*view of  
CORBA 1.x*

*not changed  
until CORBA 3*

- New, introduced in CORBA 2.0
- Standard interface for any ORB implementation
- Potential multiple object adaptors
- One stub & one skeleton for any interface (at least)
- ORB-dependent interface

- interface backup call
- usual downcall interface

C/S MW and more 16



# COMMON LANGUAGE in CORBA

---

Interface Definition Language (CORBA IDL) must **identify and coordinate requested and offered services, local and remote (for either static or dynamic interactions)**

- Both **servants** and **clients** can **identify themselves** to **make themselves** mutually **known**
- Both **operations request** and **service** offers can be **optimally associated**
- CORBA reuse the experience from already developed and available **IDLs** for defining a general multi-language IDL

Unfortunately IDL prescribe predetermined identification and link and statically recognized (CORBA static binding)

*And if we want bindings unknown at development time?*

C/S MW and more 17

## CORBA IDL for MULTILANGUAGE

---

Interface Definition Language (CORBA IDL) **coordinates requested and offered services identification, with different languages**

```
interface Factory //OMG IDL
{
    Object create(); // CORBA object or reference
};
```

This interface permits to refer an object of type Factory (IDL) and to request the **create** operation (without **in** or **out** parameters) that returns a generic CORBA object (type `Object`, that is a reference to the object of interface `Object`)

**IDL** makes possible to define **new interfaces and new general types and abstract**, by need, to make them available and registered, and eventually **concretely usable inside different language environments**

**CORBA** does **not** provide any **object creation** (neither Factory): the creation is inside language environments and predefined there, outside CORBA scopes (the same as C does not provide any I/O)

C/S MW and more 18

## CORBA IDL → STUB E SKELETON

---

The **Interface Definition Language** (CORBA IDL) allows to generate **support component (stub and skeleton)**, for communication and data, inside **different languages**

The **stub** enable working on the *message from the client perspective* (marshalling) and acting as client proxy

The **skeleton** collaborate with the ORB *accepting service request and adapting it to the server* (unmarshalling), by managing requests and responses

### DEPLOYMENT

Typically, there is a **static link** between **interface - client - servant** (*not between client and servant, but between client - service and service - servant*)

*The objects inside their different language environments are bound to the stub and skeleton before execution*  
(stub and skeleton are objects? no)

C/S MW and more 19

## CORBA ADAPTER

---

**Adapter (Object Adapter)** system component to overcome **inhomogeneity** and **differences** among implementation of different **service environments** of different servants

*(the Adapter does not connect with data presentation)*

The Adapter is on the **server** side, with typical tasks of:

- object **registration** functions
- object **external reference** generation
- object and **internal process activation** *even on demand*
- **requests demultiplexing** to uncouple them
- **send requests** (upcall) to registered objects

Firsts adapters were Basic (**BOA**), then Portable (**POA**)

*(OA are also CORBA objects? no, as OA are pseudo-objects)*

C/S MW and more 20

# INTERFACE REPOSITORY in CORBA

---

**Interface Repository** allows to know details about every **IDL data type** and to explore **interfaces**, exported from existent objects and available during execution

The interfaces are translated to different programming languages (**static binding**) where components are defined and compiled (**language mapping**)

**IR** allows to know and manage available interfaces **dynamically** and to **decide at runtime (dynamic binding)** what is available and convenient

**Allows overcoming static approach:** for example for a *gateway that allows access to CORBA interfaces of an environment and cannot be recompiled for every new interface*

**IR service description system** (it is not a naming system)

(IR is an object? yes)

C/S MW and more 21

## ORB and IR in CORBA

---

In CORBA, **ORB is the middle enabler of any (remote) execution and operation request between different entities**

Every request **is always delivered** via the ORB and then server-side mediated BY the adapter

The ORB do not know about any **type information**, that are outside his scope and contained inside stub, skeleton and **language environment**

**Interface Repository** works as a **dynamic catalogue** of **interfaces** (not necessarily for **static** stub and skeleton),

And it is present for **dynamic explorations** at runtime, if it is necessary to retrieve information on dynamic interfaces

The interfaces must be always registered within the IR at their time of use and before consultation

In the **static case**, the IR is generally not needed (its function is plaid by proxies)

C/S MW and more 22

## DIFFERENT ORB SYSTEMS

ORB for communication of objects (intra-ORB)  
and also for communication between objects in  
different ORBs (inter-ORB)

In one CORBA system or in more CORBA systems  
managing different brokers

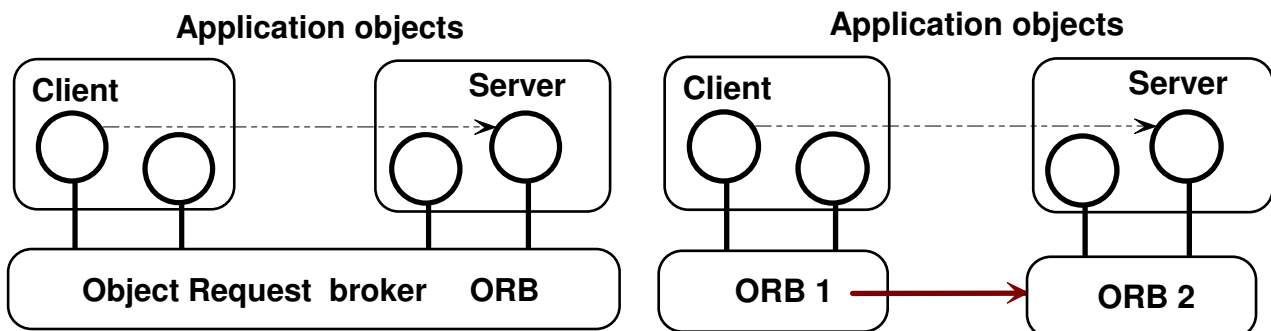

C/S MW and more 23

## DIFFERENT CORBA SYSTEMS

Definition of Inter-ORB standards to establish how to  
integrate different CORBA systems without problems

Necessity of standard protocols **ORB-to-ORB interoperability**

**General Inter-ORB Protocol (GIOP)** that prescribe a standard  
message format

CORBA specifies a protocol between different ORBs in terms of  
architecture and data exchange

**Binary Communication**

protocol: data are optimized  
and non user-readable  
(no source)

**Common Data Representation  
(CDR) standard**

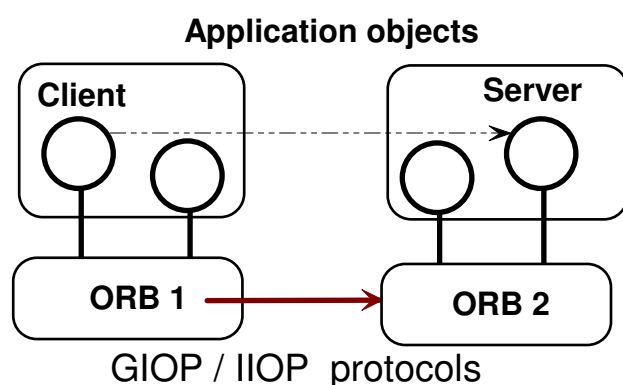

# INTER-ORB PROTOCOL: GIOP e IIOP

Definition (since version 2) of Inter-ORB Protocols to precisely the interaction between different CORBA systems

**ORB interoperability protocol**

**General Inter-ORB Protocol (GIOP) - Binary protocol**

*Common specification of data representation, data format, interaction with transport messages (semantic assumptions: reliable, connection, ...)*

for Internet using TCP/IP - **Internet Inter-ORB Protocol (IIOP)**

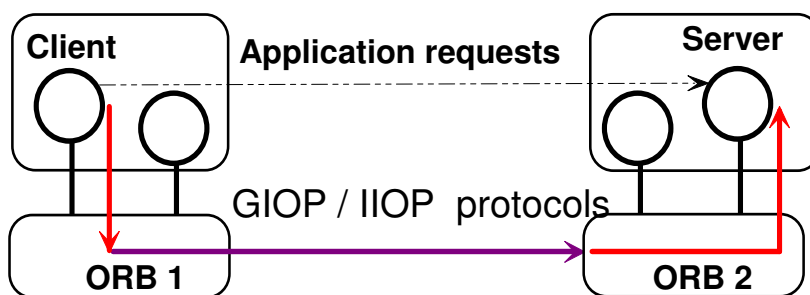

# CORBA ARCHITECTURE

Overall picture of a communication between ORBs

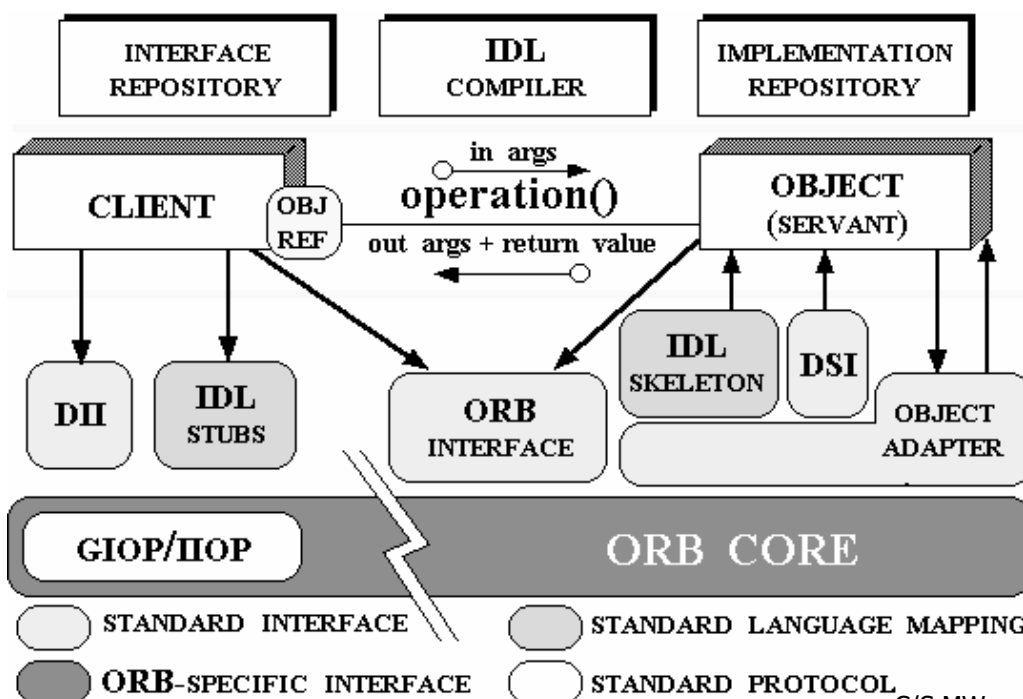

# CORBA: PSEUDO-OBJECTS

---

## Support components and pseudo-objects

**Stub** generated from IDL interface for a specific language

**Skeleton** generated from IDL interface for a specific language

These components realize the **Static Invocation Interface SII**

The SII consists also of other architecture component, such as **IDL interfaces** (to generate stub and skeleton), (interface and implementation) **repositories** to find component specifications and implementation, and **object references**

The dynamic part is implemented in other **pseudo-objects**

**DII**, **Dynamic Invocation Interface**, or *Request* object  
introduced for client dynamic invocation

**DSI**, **Dynamic Skeleton Interface**, or *ServerRequest* object  
introduced for server dynamic invocation

C/S MW and more 27

## ORB base functions

---

**ORB acts as a coordinator, as an enabler, and as a manager of services** available on the system

CORBA applications produces **objects** that become part of the system beyond **application lifetime**

The **applications** and the **objects** are developed using **different environments** to represent **stable resources** that can act to request **methods** and **execute operations**

ORB intermediates any interaction and

- **coordinates requests from client objects, transparently** from the position and the implementation of remote objects
- **facilitates and manages communication through the use of references** to existing **servant objects**
- **supports and controls** the whole **interaction**

C/S MW and more 28

## ORB functions

---

**ORB is a fully object interaction enabler, by suggesting a default blocking synchronous interaction**

**ORB limits its interaction responsibility by delegating individual language environments for final execution**

**CORBA is not responsible for object creation and moving**

CORBA employs **external remote references** that are **externally created** by language implementation environments that must define their service objects (**servant**)

**CORBA obtains remote references via:**

- conversion of **string references** and vice versa (objects referred and translated into strings - stringification, and vice versa)
- use of **objects directory**, by using name services (Trading e Naming service)
- **Passing of reference parameters to servants**

## CORBA IDL

---

**INTERFACE DEFINITION LANGUAGE (OMG IDL)** has been introduced to grant flexibility over heterogeneous platforms

IDL are **declarative languages** to **specify interfaces** and **involved data** (for API parameters)

Many common IDL are **procedural**

- \* **OSI ASN.1 / GDMO**
- \* **ONC XDR (SUN RPC)**
- \* **Microsoft IDL**

**CORBA IDL is an object-oriented language (*derived from C++*)**

Obviously, different IDLs are **not compatible** with each other, even if often are different only for **syntax** and **identification systems** and **entity names**

# CORBA IDL

---

**CORBA IDL** is a purely **description language for data and method interfaces**

- description of **interfaces definition**
- **interfaces** as sets of method and attributes
- **multiple inheritance** of interfaces
- **exception** definition
- automatic management of **attributes**
- **mapping** for **different languages** and environments

*The compiler can obtain automatically stubs for clients/servants even using different languages*

We must consider different **language mapping for references to servant objects** (in different languages)

C/S MW and more 31

---

## CORBA IDL EXAMPLE

---

```
module Stock
{exception Invalid_Stock {}; exception Invalid_Index {};
  const length = 100;

  interface Quoter {
    attribute float quote; readonly attribute float quotation;
    long get_quote(in string stock_name) raises (Invalid_Stock);
  };
  interface SpecialQuoter: Quoter {
    attribute float quotehistory [length];
    readonly int index [length];
    long get_next (in string stock_name) raises (Invalid_Index);
    long get_first(in string stock_name) raises (Invalid_Index);
  };
  interface CancelQuoter: SpecialQuoter {
    long cancelhistory (out float cancelledquote [length])
  };
}
```

C/S MW and more 32



# CORBA IDL SUPPORT

For any attribute, an automatic access function is provided suited for permitted operations  
(`_get` for readings and `_set` for writings)

```
attribute float quote;  
float _get_quote ();  
void _set_quote (in float q);  
readonly attribute ind index;  
float _get_index ();
```

For any exception, the state (`completion_status`) provides information on behavior semantics

```
COMPLETED_YES,  
COMPLETED_NO,  
COMPLETED_MAYBE
```

## CORBA IDL

Language to define CORBA interfaces, independently of a **specific programming language**

Naturally it is necessary **pass** from the abstract **CORBA level** to concrete **specific languages (language mapping)**

CORBA specifies the need of **mapping environments**  
**Servant creation** is a responsibility of each language mapping

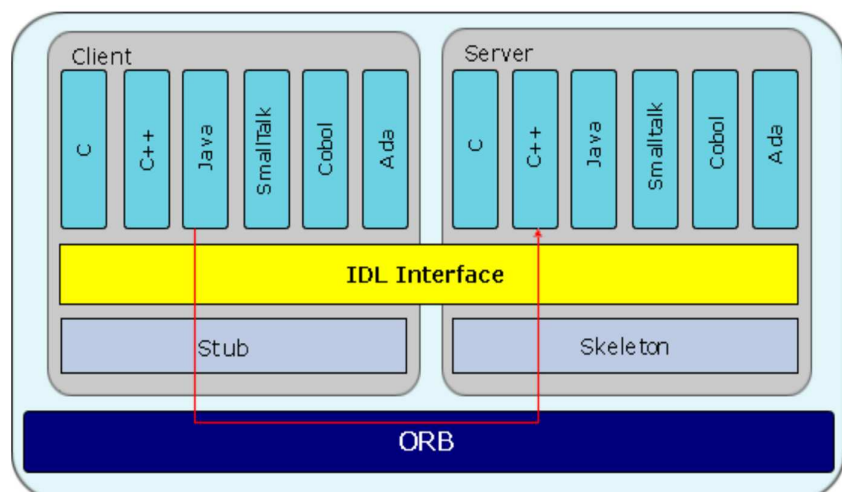

# CORBA IDL ENVIRONMENT

---

CORBA is an **environment** where **we use remote references and do not move objects (static objects)** because of **the heterogeneity of single deployment environment**

**Remote references** allow to request operations to other components with known CORBA interface

**Every object has an interface (coarse granularity)**

**Interfaces** define: **attributes, methods, exceptions**

(*attributes accessed through **get** and **set** operations*)

(*operations with **in** or/and **out** arguments*)

The interfaces use **multiple inheritance**

The **interfaces** can be grouped also within **modules**

(*for logical aggregations*)

# OTHER CORBA IDL EXAMPLE

---

```
module BankAccount {  
  struct transaction { string data; float amount;};  
  exception RedException {string message;};  
  typedef sequence <actions> list_ops;  
  interface Account {  
    float balance(in string cc);  
    list_ops bankStatement (in string cc);  
    void withdrawal (in string cc, in float amount,  
      out float balance) raises RossoException;  
    Account accountTwin(); // returns an object };  
};
```

**Parameters passed by value (CORBA objects by references)**

**Problem of parameter handling in out and in out**

# DATA in CORBA IDL

## Types in CORBA

**Object Reference** (references to **objects or interfaces**)  
vs. even with inheritance between CORBA objects

**Value** (values copy) and **Exceptions**

**Basic values** short, long, ushort, ulong, float, double, char, string,  
boolean, octet, enum, Any

**Constructed values** Struct, Sequence, Union, Array

**Any** as general type that contains any type, primitive or from CORBA interface (analyzable during execution)

### Object by value (CORBA 3)

Objects that **cannot** be accessed remotely but only passed **by copy** from an environment to another one overcoming heterogeneity of different environments (no remote reference to them)

# TYPES in CORBA IDL

## Types in CORBA IDL

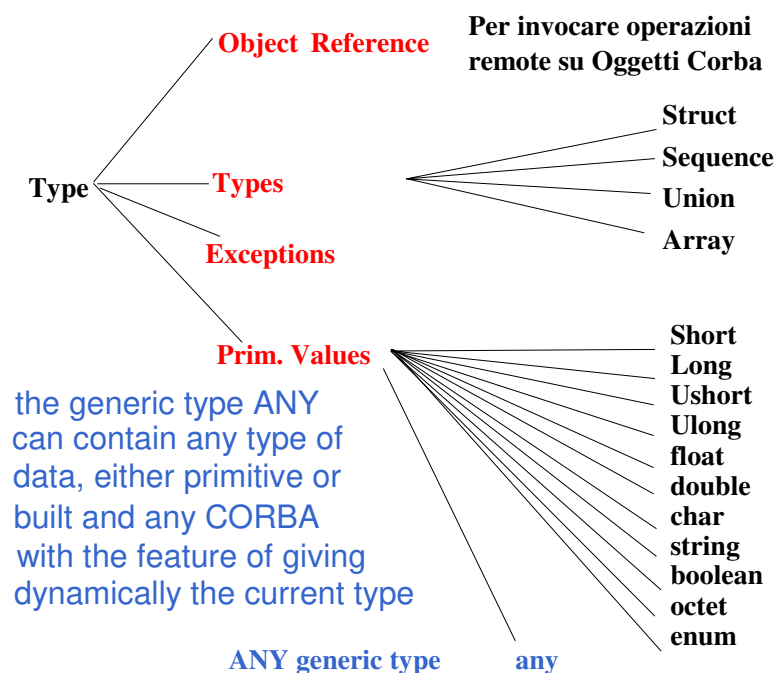

**Types of CORBA IDL are then translated into types of different programming languages obtained for different language mapping**

**Type Object (IDL) represents any type of CORBA object without any information of the specific type**

## From CORBA IDL to Languages

**Tools** allows to build from CORBA IDL different components, essential to the project and to execution in **different language mapping**

**stub** and **skeleton**  
+ **file helper**  
and **of other help (holder)**  
+ other operations

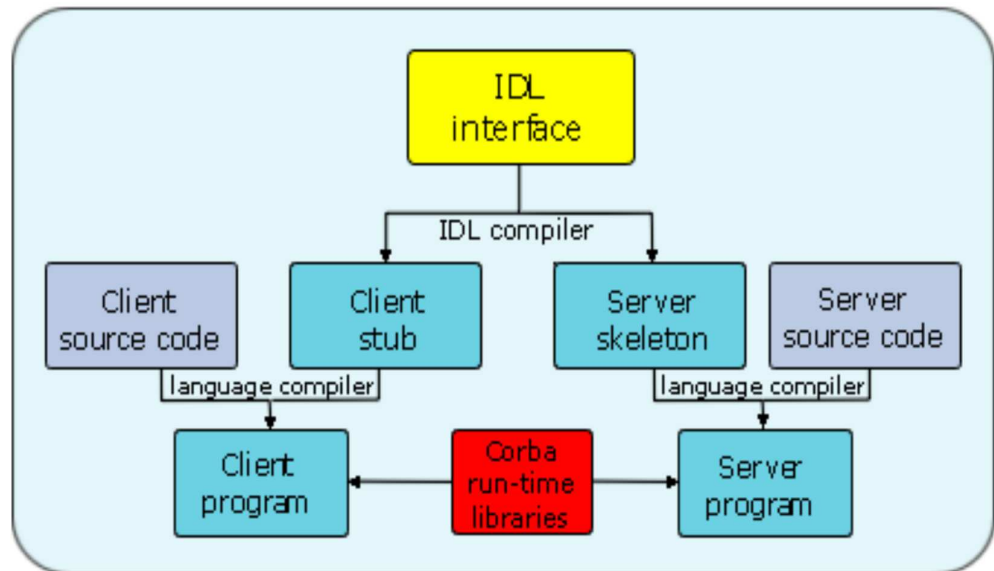

## CORBA Language mapping

**CORBA defines**

**interfaces** (with inheritance), **exceptions**, **methods** with **objects as parameters** of different types and with different **modes** (**in**, **out**, **in out**)

**Different languages** must add **tools**, to harmonize their **structures** to obtain **interface conformance** and guarantee **run-time operations** (**OO languages must integrate inheritance**)

**Strategy for consistency of concrete language types and possibility of integrating with the CORBA model**

various transformation functions provided automatically management of types, to put together structures in simple way,

Apart from many other support functions (naming, trading, and suggested development methodologies) usable by user

## CORBA vs LANGUAGES: HOLDER

---

Use of **holders** in JAVA as language where are output parameters for example

```
public final Class BalanceHolder ...  
{public float value;  
public BalanceHolder() {}  
float _read() {return value;}  
void _write(float value) {this.value = value;}  
};
```

for **out** and **in out** parameters (also other helps: helper)

In general, **every language must create anything that is necessary to foster development inside its environment**

## CORBA HELPER

---

**Helper** use for Language mapping: in Java functions to

- **harmonize and treat language types and CORBA types**

*In Java the **CORBA Object** type is mapped in `org.omg.CORBA.Object`*

functions of **narrow-ing** that transform from the CORBA Object type to the one defined inside the interface

functions used for managing **transformations from abstract CORBA type** for the specific concrete type of interest

- **implement various utility functions**

functions for **reading and writing** a type on an object stream (associated to CORBA interface), to **treat type dynamically** during execution, ...

Every **language** must guarantee interoperability with CORBA

# CORBA ENVIRONMENTS AVAILABILITY

---

## Widely used and still rising

Object Broker	DEC
ORB	HP
DSOM	IBM
<b>Orbix</b>	IONA
<b>Visibroker</b>	Borland
(DOM Facility)DOE	Sun Studio Sun
<b>PowerBroker</b>	ExperSoft

**JacORB, ...**                      **Open source tools**

Even if the learning curve is high and there is overhead in performances

C/S MW and more    43

---

## NOT ONLY C/S: ADVANCED C/S MODELS

---

### ***Many variant of the Client/Server model***

#### **Novel variants**

##### **pull (synchronous non blocking)**

(the client get afterwards the result, without waiting for it)

##### **push (synchronous non blocking)**

(the server gives the result afterwards to the client that do not wait for it)

##### **delegation** waiting for the result **(synchronous non blocking)**

(the delegate *waits for the client* and gives it the result)

##### **notification** for the result

(the delegate notifies the client that a result is arrived)

##### **events (typically asynchronous, so non blocking)**

(an event is generated from producer and advertised to consumers)

##### **provisioning**

(other parties can be interested in the call chain, apart from C/S)

C/S MW and more    44

# DELEGATION – TO GET THE RESULT...

*In a synchronous non blocking model, we may have a delegated entity for handling the result*

We add a new objects, typically called **Poll** and **Call-Back** objects as intermediate entities

## Poll Object

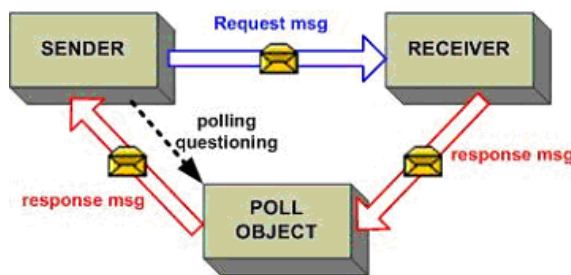

Used for short operations  
response time

## Call-Back Object

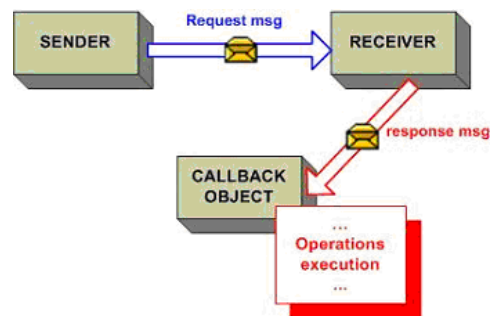

Even long operations and limited and  
independent from the client life cycle

**We should define specifically the organization in any case**

# MESSAGE EXCHANGE

## *Model of MESSAGE exchange*

*very flexible but primitive, not user friendly*

Sometimes the message are only for the **synchronization** (signals) without any real data **communication** (carrying **no information**)

Information exchange: **properties**

**a/ synchronous**

(**no** / result)

**a/ symmetric**

(the same knowledge of partner)

**in/ direct**

(intermediate entity or not)

Implementation

**non/ blocking**

(**un**/blocking of the sender)

**un/ buffered**

(non / message queuing)

**un/ reliable**

(with/without message loss)

Models with **multiple receivers** or **group messages**

**multicast (MX) and broadcast (BX)**

# MODES of MESSAGE EXCHANGE

---

**MESSAGE EXCHANGE varies a lot in different systems**

## **Rendez-vous**

One to one message exchange that is **synchronous, blocking, symmetric, unbuffered, coupled** (more than C/S)

## **With an intermediate entity (channel, ...)**

Message exchange typically **asynchronous, non blocking, asymmetric, decoupled** (less strict than C/S)

## **With intermediate entity & receivers group (events, ...)**

Message exchange typically **asynchronous, non blocking, asymmetric, decoupled and many to many**

C/S MW and more 47

# C/S vs MESSAGE EXCHANGE

---

## **Client/Server**

Model with strong coupling

implies **co-presence of interacting parties**

Mechanism suitable for high-level and simple communication

Very **high level** (very suitable for application usage)

but **not so flexible** for differentiated situations,

no Multicast (MX) and Broadcast (BX)

## **Sender/Receiver message exchange**

Model with loose (minimal) coupling

imposes no **co-presence of interacting parties**

Very flexible, primitive, and expressive mechanism, maybe not so easy to use

Very **low level** (and suitable for any system potential usage):

many **differentiated modes of usage**, even easy support to any kind of needed communication, e.g., any form of **MX** and **BX**

C/S MW and more 48



## DE / COUPLING

**Communication tools** can impose some **constraints on the interacting entities (also no imposition)**

These constraints can even induce severe limitations on the interaction and force knowledge needs sometimes not required

### Different ways of coupling

#### - space

The interacting entities must know each other and be co-located

#### - time

The interacting entities must be present at the same time (they should share some intervals of time)

#### - synchronization

The interacting entities must wait for each other and are subjected to reciprocal limitations and blocks

**Decoupling becomes a factor to enable greater flexibility and to leverage the potential distribution of the load in a system**

C/S MW and more 49

## EVENT and PUBLISH-SUBSCRIBE

### **Decoupling between interacting entities**

**Events are generated by producers**, free of doing it when they intend to generate events (**publish or PUB**) **without worrying about delivery**

**Consumers** register their interest in specific events, topics, ... (they have **subscribed SUB**) and the **event support** is in charge of the delivery

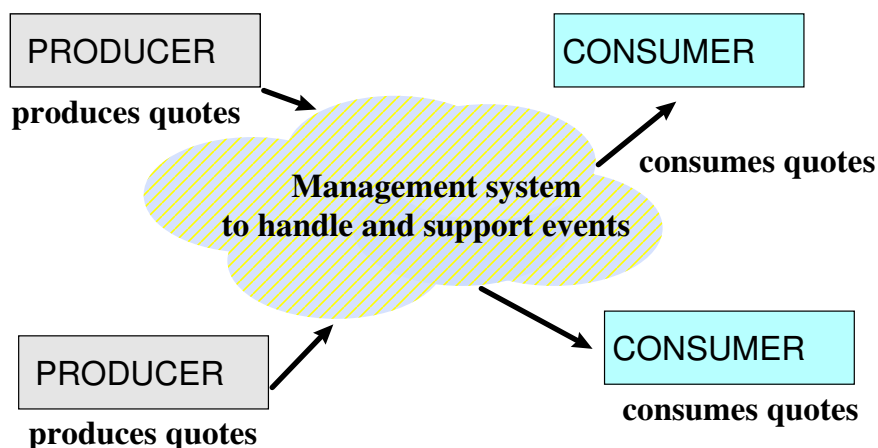

**Producers and consumers are not required to be present at the same time**

C/S MW and more 50

# FROM LOCAL EVENTS

**Different model than a synchronous requests of C/S t**  
**The Framework tends to reverse the control for low level events**

*The user process does not wait for result but register with a handling action*

Example: **Windows asks all processes to provide a waiting loop to serve with the it is going to raise to them (and send to them)**

*When the result is produced the event is raised an the process can go on*

Responses from the framework to the user are called

**backcall** or **upcall**

They are similar to an asynchronous event generated by the framework and that application must manage through a **handler function** specified by the user

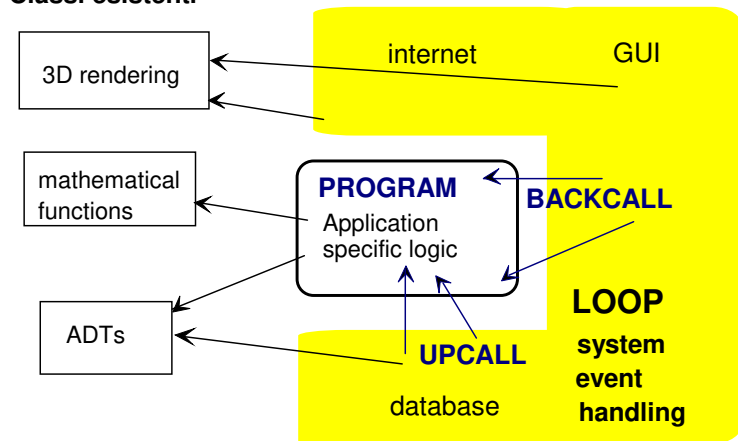

**Available Services and Functions**

## EVENT SYSTEMS (DISTRIBUTED)

**Event systems** have been modeled and designed without any locality constraints (no coupling)

The model has its strength in the non-locality of interacting entities only local implementations

Local implementations are not interesting (such as using the sharing on the same node, between producer and consumer), **arbitrary, and not meaningful downsizing** of the model

**Develop a system for events not taking into account the potential decoupling, ...**

means to use badly the model properties, one of the worst things we can do to a technology

If you constrain the events to the co-residence and co-presence of interacting entities, you produce a deployment that contrasts with the basic event model

# EVENT SYSTEMS: INDICATORS

---

**Event systems** have been defined to model **large systems** and **scalable ones**

Some **indicators are core ones**

**Cost in distributing events (to limit)**

**Performance (to optimize)**

**Scalability (to keep high)**

**Latency (to limit in time)**

**Pervasivity of provided services (to keep high)**

**Independent develop and execution (high)**

**Fault tolerance (maximal possible)**

When you implement **event systems** you start from **viability**, to mean that you grant that the **indicators are scalable**, in other words for all distributed implementation indicators keep **acceptable values**, possibly '**constant**'... at least **tested**

C/S MW and more 53

# EVOLUTION of EVENTS

---

## **Primitive events**

some **events** are **on/off signals** without any content information

*interrupt events and signals triggered by low-level handling functions*

## **Events that carry contents**

some **contents** carry information and one can also **filters** events based on **interest** about **specific information**

*RSS as an example, where there is interest only to specified topic and users can register to specific interests*

## **Events with quality - Quality of Service**

These **events** can provide **differentiated service** for **different users**: they can persist and be maintained for all or some users, the **delivery** can be different depending on receivers, ...

***Persistent events**: users not online do not lose any event, kept to be delivered a.s.a.p. when they are on*

***Event priority**, e.g., depending on the number of resources devoted to users*

C/S MW and more 54

# PUBLISH-SUBSCRIBE SYSTEMS

PUB-SUB systems are **advanced distributed systems** based on the **event model** and **message exchange** to take the best advantage of the flexibility and the decoupling of interaction to increase **scalability and distribution**

The PUB-SUB model has also many other flexible aspects...

## Message filtering based on

**topic-based**: based on a predefined topic (a specific interest between different channels: such as a specific RSS)

**content-based**: based on message contents (some keywords or also some more complex relationships)

**type-based**: based on message type (in case of different message types and a selection done on them)

## Quality of Servizio (QoS) over messages

Persistency, Priority, Guarantee of maintenance and duration, ...

# PUBLISH-SUBSCRIBE SYSTEMS

Real PUB-SUB systems support **operations for consumer subscription**

**producers** called also **publishers** provide events (they might ask which are current subscribers)

**consumers** or **subscriber** that have subscribed must receive events, via a notification

an **infrastructure** must ensure and grant the operations

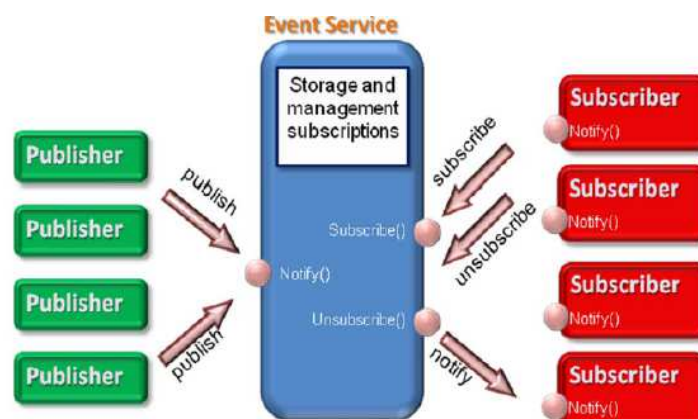

# DECOUPLED MODELS - TUPLE

---

## **TUPLE MODEL for loose and scalable interaction**

### A general model for communication and synchronization

designed as a *shared memory abstraction + communication*

A **tuple space** is a set of **structured relationships**, organized as a container for *attributes* and *values* for PUB-SUB

On a tuple space tuples can be deposited / extracted **high-level information** without **causing any interference** or incorrectness

A possible relationship: **message (from, to, body)**

The space is a container of **tuple values** according to the defined attributes (the *attribute types*, here ASCII string)

**Tuple values** *message*: {**Antonio, Giovanni, msg1**}

{**Giovanni, Antonio, msg1**} {**Antonio, Giovanni, msg2**} ...

There are no constraints on tuples that can be deposited and stay in the space forever (almost, it is a model) so **without time** or **space limits**

C/S MW and more 57

---

## TUPLE - Linda (Gelernter)

---

### Operations of **In** e **Out** on the tuple space

Tuple spaces offer operation always possible and correct for **readers (In consumer)** and writers (**Out producers**) competitors with access based on attribute contents

**Out** inserts one tuple in the space and **In** extracts one tuple from the space

The **Out** operation **emits a tuple** on the space available for a match with an **In** request and the tuple stays there until it is consumed by one corresponding **In** only

The **In** operation **extracts one matching tuple** from the space, if exists. If it does not exist, the **In** waits until one is received for the **match that is based on pattern** on the attribute values

In case of match with **multiple tuples**, only one is **non-deterministically extracted**

**Out:** message (P, Q, text1)

**In:** message (?from, Q, ?body)

The **In** may have name of attributes for larger matches

The **In** waits for one tuple with the second attribute the string Q, and give to the consumer the values **from(=P)** e **body(=text1)** of the matching tuple

C/S MW and more 58

# DECOUPLING TUPLE

---

## Tuple spaces

The communication is rather **decoupled** and **asynchronous**

### In time

A producer can deposit tuples and go away, and only after a **long time**, the consumer can arrive and get the tuples

### In (reciprocal) knowledge (space & synchronization)

The consumers do not know the producers in any way, but only the tuple contents they cannot interfere in any way with production (*one **in operation** extract one tuple, other **in-s** are queued and wait for their matching tuples and **outs operations***)

### In quality - QoS

Tuple spaces are **persistent** and their requirement is to **maintain deposited tuples without limit (in memory and time)** without any preference for a specific requesting process

Tuple spaces (local implementation) are available to favor local communication **well formed** and **with high level operations**

Javaspaces, ...

C/S MW and more 59

# GROUP COMMUNICATION

---

## Communication within a set of processes

### Broadcast e Multicast

How to send general messages either to all currently present processes in the system or to a subset of processes (a group) in the system?

In a **single location** you can easily achieve it (in the same LAN)

On different **networks and locations**, you cannot easily achieve it  
*expressive incapacity, excess overhead, lack of QoS, ...*

### There are some semantic problems to solve in multicast and broadcast

How to cope **with the answers** (if any)?

- **no wait** – **asynchronous** operations
- wait for **one answer only**
- wait for **some answers only** (how many?, how long?)
- wait for **all answers** (how many? how long? **When to stop?**)

C/S MW and more 60

# GROUP COMMUNICATION

---

## IP Broadcast

**Broadcast** limited and directed (inside local network)

## IP Multicast **heavier duty and protocol**

**Multicast** for class D addresses

### **Local Multicast support and ...**

Internet uses **Internet Group Management IGMP** protocol since long ago (**RFC 1112 e 2236**) to **implement local multicast**

Often the **protocol could operate only on local subnetworks**, and it is implemented in different and not compatible forms

### **Multicast (more) global support**

**A multicast** is realized by **flooding between networks**

**a packet can traverse a node only once (node with state) and is sent via any output queue apart from the one where it came in (how long to keep the state?)**

Traditional way of routing with simple and low cost (!) policies

C/S MW and more 61

# IP GROUP COMMUNICATION

---

## **One can adopt some basic strategies with mechanisms**

*For example*, we can use an a-priori dimensioning of time-to-live (TTL) of datagrams (to specify penetration and cost)

TTL=0 local send                      TTL=1 local to connection

TTL<=32 local to area                TTL<=64 local to region

TTL<=128 local to continent        TTL>128 global

## **IP Multicast and the QoS?**

How can we be sure that the message has been delivered (beyond best-effort semantics)?

### **There is a limited guarantee on IGMP implementations**

*that is*

*We do not know if messages were all delivered to all recipients and in which order*

C/S MW and more 62

# GROUP COMMUNICATION

---

## IGMP as an example of **local support to Multicast** (RFC 1112 e 2236)

IP multicast allows to send a unique packet to multiple receiver in the same locality, by using class D names to identify a group, not necessarily a local one but spanning a few local networks

The IGMP needs a **support from management router**

*Every local network must hosts at least an IGMP router capable of managing local incoming and outgoing traffic and it controls the group with IGMP messages. It is possible to provide more multicast routers*

**IGMP v1** considers only **two simple messages** with C/S approach

**IGMPQUERY** a **router** periodically verifies the existence of hosts that answer to a specific IP D address

**IGMPREPORT** a **node** signals a state change to the router related to the group (only **join the group** and no **leave**)

C/S MW and more 63

---

## IGMP VERSIONING

---

### IGMP v1

#### **Routers are in charge of group management**

There is only a **join** message, but no **leave** message from the group in v1  
Any router has always an **active** role that require to regularly emit queries: nodes reply to the query to signal their presence or do not reply (problem with nodes that **answer late to the first join query**)

*this version requires group operations (only one single report from a node for a single local network)*

### IGMP v2 (support for join / leave)

The second version consider the capability of nodes to send a message of **explicit leave** (i.e., leave the address group)

Nodes that leave the group must notify the manager

#### **More routers can be in charge of the management**

*Interference between router is settled with IP numbers order*

C/S MW and more 64



# ROUTING MULTICAST PRINCIPLES

**Multicast must employ the least resources as possible during data transmission to receivers**

Some assumptions tend to obtain an optimal use of resources and to avoid an excess of bandwidth

- **single sender** support
- **variable number of receivers** support (up to  $n$ ), that can be added or removed dynamically

The main idea is to maximize **sharing**, so to **send only one copy**, instead on  $N$  ones, of the same **multicast** message (1 message cost) **instead of different unicast** ( $N$  message cost)

Derived from assumptions, protocols identify a central **tree** starting from the sender with **optimal shared paths from sender to current receivers**

**The goal is to employ most shared hops as possible from root to leaves**

the continuously changing tree must consider only currently active receivers and disregard the ones where there are no currently active receivers

C/S MW and more 65

## ROUTING MULTICAST (STABLE)

**Multicast** requires the **identification** of a (dynamic) tree from **sender to receivers for repeated forwarding**

the sender is the **root of the tree**, the intermediate routers are the **intermediate** nodes and identify subtrees, the receivers are the **leaf nodes** in the tree

- an open group of nodes with a **single sender**
- the group membership is **dynamic**
- leaves are responsible for **joining the group**
- **shared paths optimize bandwidth**

**The tree is extremely dynamic**

Consider the case where an **host S** transmits and **B** and **E** are in the receiver group

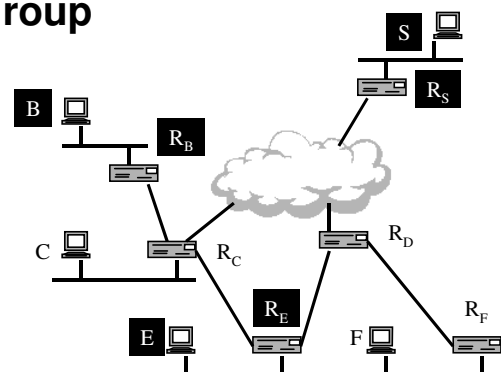

C/S MW and more 66

# MULTICAST: SPANNING TREE

We consider only routers as participants (no nodes) and we want to build a tree from the interconnection graph

## First step (request for leaf identification: root to leaves)

We want to build a tree (a **spanning tree**) that connects root to known leaf nodes, typically by using unicast routing protocol information and **organizing and aggregating paths**

We start sending a **flooding** message towards **every possible recipient** with the main objective of creating a **bone multicast**

The root identifies shortest paths by building it from replies from receivers

some receivers nodes are reached through multiple paths

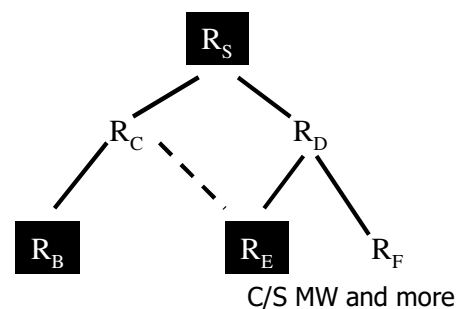

67

# MULTICAST: MULTIPLE PATHS

## Second step (go back from leaves to root)

Every leaf signals direct **paths** (backwards) and can also **identify new paths** (even not shortest) for going from root to leaves

*minimal path messages* are sent backward from leaves to root

only some paths are selected, other are discarded

some *shortest path messages* from the source are sent back in a **larger scope**: they are forwarded from leaves on all exit links, except the one where it was coming (to identify other better paths not traversed from root to leaves)

## Reverse path forwarding (backward path)

For every router reached from several path, the root can so select the best

R<sub>e</sub> is reached from R<sub>d</sub> but it can try to identify other routes in order to determine new shared parts

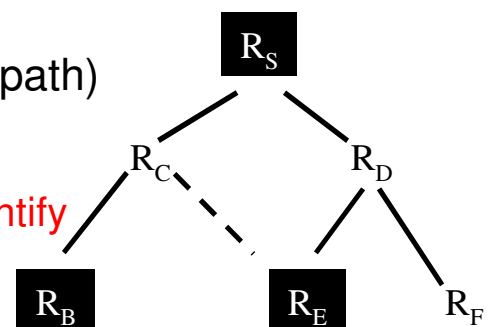

C/S MW and more

68

# MULTICAST in ACTION

**Normal routing: normal routing operation must work continuously while tree identification is ongoing...**

## Distance Vector

Next hop information must be used (or use poisoned reverse) in order to block too long paths

## Link State

All shortest path trees must be built for every node and use "tie break" rules to settle conflicts

## Reverse Path Broadcast (2 step) for

### deleting Multiple Paths

Leaves send a broadcast towards the root during normal routing operations

The root receive new paths and can reorganize the tree trying to aggregate several sub-paths and produce an optimal tree

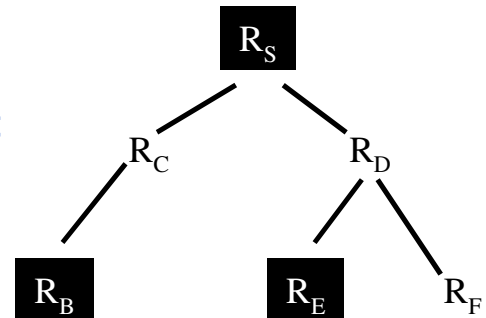

C/S MW and more

69

# REVERSE PATH BROADCAST

**Reverse Path Broadcast** allows to choose between different paths to organize the optimal tree, while minimizing the number of sent messages and used bandwidth

With a broadcast from leaves (the **Reverse Path Multicast**) it is possible to **find paths, connecting leaves with the root, that have not been previously explored**

It is up to the root to choose the best tree organization

**Reverse Path Multicasting (RPM)** to reorganize the tree (even with a high cost)

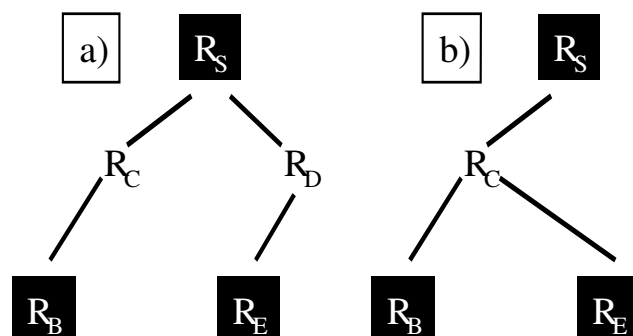

C/S MW and more

70

# MULTICAST: PRUNING and GRAFTING

## PRUNING and GRAFT

routers that have no receivers connected are excluded with 'cut' messages that flows throughout the tree

***The tree must be rebuilt in case of any modification***

### Reverse Path Multicasting

(RPM) autonomously done by the leaves to consent

**PRUNING** - from a) to b)

and reinserting parts of the tree

**GRAFT** - from b) to a)

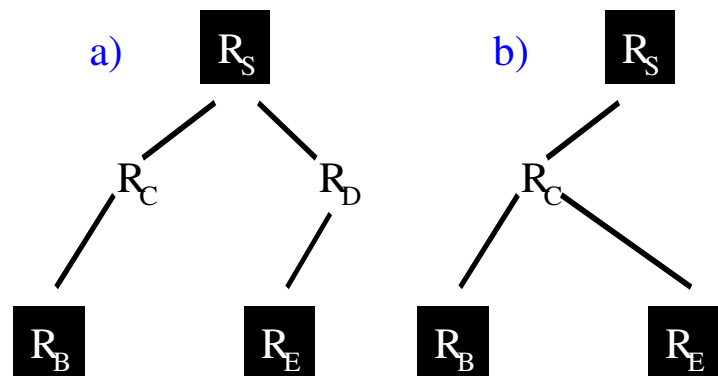

## REVERSE PATH MULTICAST

**Reverse Path Multicasting** from leaves to root (not a broadcast)

- used in a lot of multicast protocols
- keeps the state for communication **per-sender, per-group**

Networks with no members are **pruned out** from the tree and new ones can reenter the group (**explicit graft** from the bottom) without reorganizing the tree from scratch

**The state (software) is kept for a limited and predetermined time**

### SOFT-STATE

The definition of the **RPM time interval** is critical

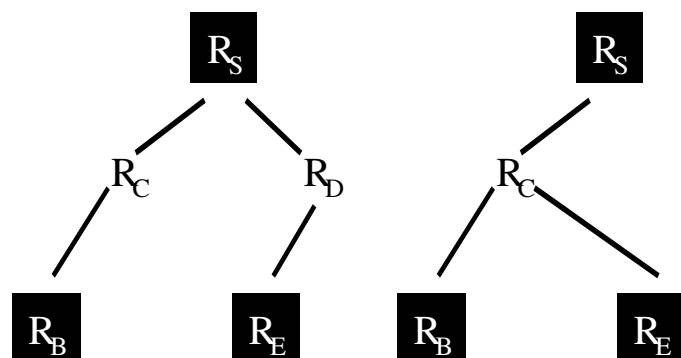

# DIFFERENT MULTICAST PROTOCOLS

---

There are many different **routing multicast** protocols, **incompatible** with each other, even in competition between themselves and supported by different communities

## **DVMRP (RFC 1075) Distance Vector Multicast Routing Protocol**

Employs RPM, based on a modified version of RIP and very used in MBONE (multicast backbone)

Update messages are sent using special paths (tunnel) and using only some nodes

## **MOSPF (RFC 1584) Multicast Open Shortest Path First Protocol**

Extends link-state, suitable for big networks, based on RPM and soft-state

It starts from networks map and uses them to calculate shortest path to every single destination

It optimizes the trees and removes not used paths

C/S MW and more 73

# MANY STANDARD MULTICAST

---

## **PIM (RFC 2117) Protocol Independent Multicast Protocol**

Uses any unicast protocol in different ways so to suit different systems

**Scattered** intended when there is a low probability of multiple nodes on the same LAN and **Dense** where there are many neighbors routers

**Scattered**: removing the most number of intermediate router to simplify the tree structure

**Dense**: use of flooding and prune, simplified with regard to DVMRP

## **CBT (RFC 2201) Core Based Trees**

suitable for an organization based on core routers to choose

Some **nodes are fixed** (core) and **trees are unified** without defining a per-sender or per-group state

It is possible to use sub-optimal tree organizations to avoid reorganizing connection for every multicast reconfiguration

C/S MW and more 74

# MULTICAST PROTOCOLS

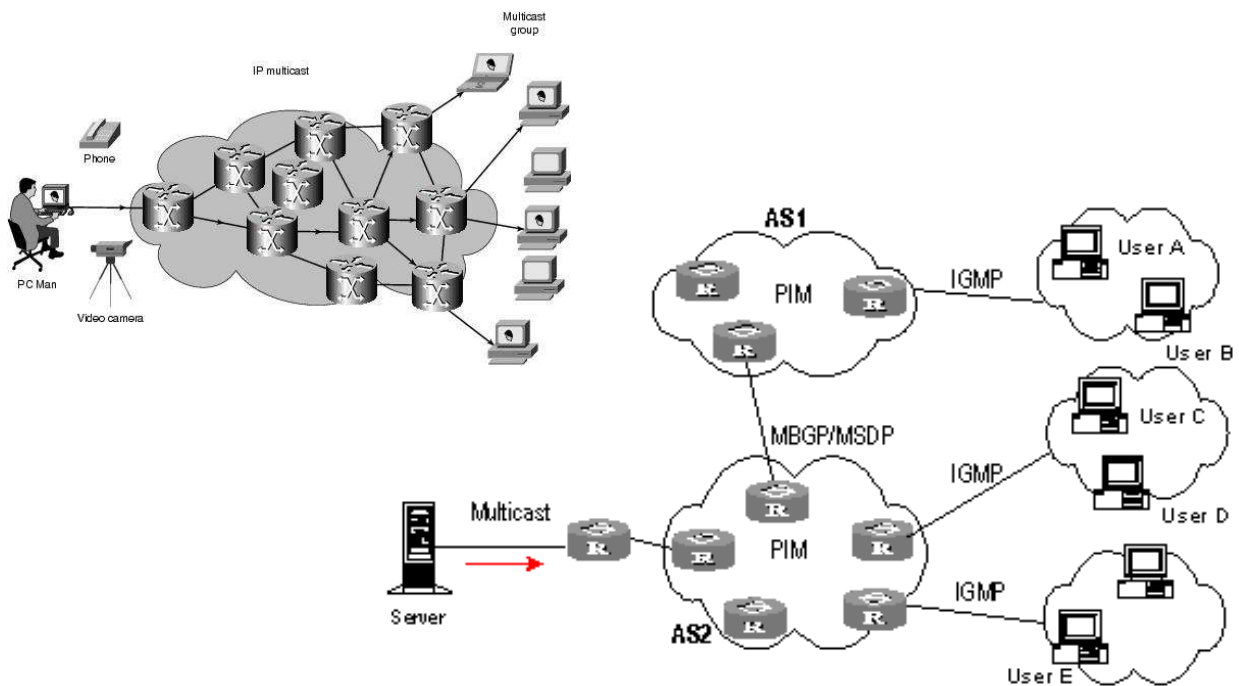

C/S MW and more 75

# MOM MIDDLEWARE

## Message Oriented Middleware (MOM)

Data and code distribution via **message exchange** between **logically separated entities**

**Typed & un-typed message exchange with ad-hoc tools both synchronous and asynchronous**

- **wide autonomy** between components
- **asynchronous** and **persistency** actions
- **handler (broker)** with different strategies and QoS
- easy in **multicast, broadcast, publish / subscribe**

Example: Middleware based on messages and queues  
**MQSeries IBM, MSMQ Microsoft, JMS SUN, OMG DDS, MQTT, RabbitMQ, Active MQ, ...**

C/S MW and more 76

# MOM DEPLOYMENT

The **specific deployment** and the **interconnection graph (OR)** is **always static (without the need of a name system)**

**Network overlay** model between different applications with **specific support in distributed environment**

**Necessity of high-level Routing (as in ONs, but static)**

**Data treatment** while communicating between **different environments**

**Predefined and static participating entities**

## Centralized model

MOM with a central node as hub-and-spoke that is responsible of support and pass messages between **different clients**

## Distributed model

MOM is located on any client node to form a static ON network, that operate through P2P communication messages between nodes in need of communication

# MIDDLEWARE MOM

## MOMs provide simple and efficient services

Communication operations available via local ad-hoc API

**MOMs put together** different nodes and provide services on different **fruition nodes** arranging **queues for the support of every communication**

**MOMs as integrators** use of **routers, their interconnection and format conversion**

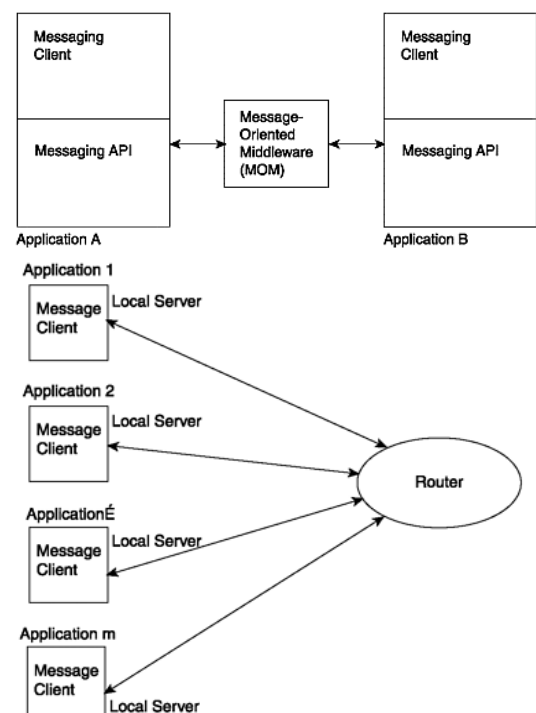

# MESSAGE-ORIENTED MIDDLEWARE

**MOMs** use **queues local to interested nodes**

**Inbound and outbound queues** on interested **different machines** (connected in an univocal way)

**Queue managers** guarantee the expected operation level and message forwarding

**Routing system** to connect different queues  
(as an **overlay network** for application level routing)

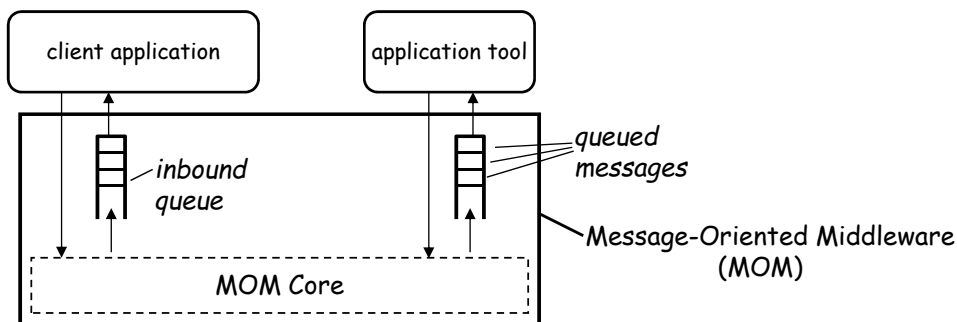

Copyright Springer Verlag Berlin Heidelberg 2004

C/S MW and more 79

## MIDDLEWARE MOM or GLUE

By following a **'Glue' model**

MOMs keep together **different autonomous systems** and organize their specific **interconnection**

**Relay** are **intermediate** entities that allow the implementation to scale and to organize high level **routing**

**Message Broker** are entities able to support message content transfer between **environments** with **different representations**

The **MOM** operations use **not only asynchronous point-to-point messages**, but also **many-to-many communications**

The **realization cost** must be **limited** and **reduced**:  
the main objective is to fast integrate **existent legacy systems**

C/S MW and more 80



# MOM: MQSeries IBM

## MOM proposal very popular and supported

Typically, the **interconnection graph (routing)** is controlled by an **always static** and **inflexible** system management (**no name servers and no dynamicity**)

**Application level messages** are managed by a **queue manager**

Processes interact through *API RPC* to put/extract messages from local queues

**Transfers** are enabled by unidirectional **channels** managed by **Message Channel Agents** that deal with all details (different delivery politics, message type, etc.)

**MCA coordination** is offered via **primitives** that should enable flexible coordination (different activation policies, duration, maximum allowed cost, state persistence, etc.)

C/S MW and more 81

## MQSeries IBM – Websphere part

For the deployment, **the system administrator** defines the **appropriate interconnections** by using **routing tables**, **at the configuration time**

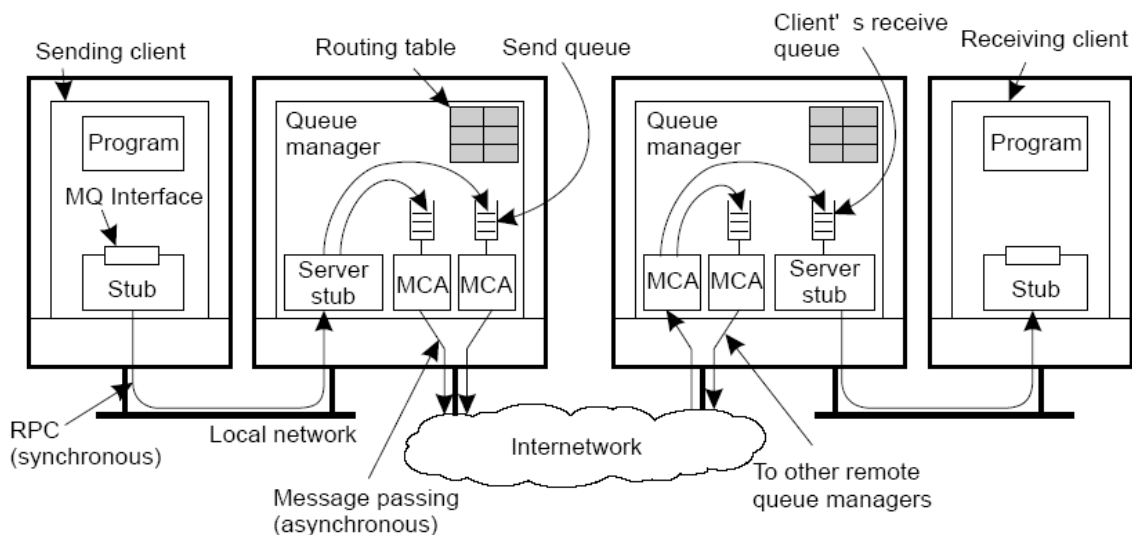

C/S MW and more 82

# MQSeries IBM: Broker

To achieve the best integration, an **MQ Broker** can operate on the messages by:

- modifying **formats**
- organizing **routing** based on **contained information**;
- working on **application information**, to **specify action sequence**

